



# TRASH CHUTES



595 E. Lugbill Road • Archbold, Ohio 43502 • www.graniteind.com

Toll Free: 877-447-2648  
Fax: 419-445-3304

## DURABLE

- Constructed of Medium Density Polyethylene
- Intake Hopper Throats – HD 12 Ga. steel
- Large 32” diameter

## VERSATILE

- Handles solids & liquids
- Excellent low temperature impact strength
- High abrasion resistance



## ECONOMICAL

- Saves on labor costs
- Reusable job after job
- Stores easily

## SAFETY, PERFORMANCE & RELIABILITY

### TYPICAL CHUTE AND HOPPER CONFIGURATIONS

NUMBER OF HOPPERS	NUMBER OF CHUTES																							
	6	7	8	9	10	11	12	13	14	15	16	17	18	19	20	21	22	23	24					
1	293#	331#	369#	407#	445#	483#	521#	559#	597#	635#	673#	711#	749#	787#	825#	863#	901#	939#	977#					
2	358#	396#	434#	472#	510#	548#	586#	624#	662#	700#	738#	776#	814#	852#	890#	928#	966#							
3	423#	461#	499#	537#	575#	613#	651#	689#	727#	765#	803#	841#	879#	917#	955#	993#								
4	488#	526#	564#	602#	640#	678#	716#	754#	792#	830#	868#	906#	944#	982#										
5	553#	591#	629#	667#	705#	743#	781#	819#	857#	895#	933#	971#												
6	618#	656#	694#	732#	770#	808#	846#	884#	922#	960#	998#													
7	683#	721#	759#	797#	835#	873#	911#	949#	987#															
8	748#	786#	824#	862#	900#	938#	976#																	
9	813#	851#	889#	927#	965#																			
10	878#	916#	954#	992#																				

The following counterweight table is given for reference purposes only, and is not to be taken as a guideline. Each job is to be figured individually based upon its own specific conditions (number of hoppers, number of protective liners, etc.). The following table is based on a system with one top hopper intake, outrigger and basic support frame.

CHUTE LENGTH UP TO	MINIMUM NUMBER OF 50-LB. COUNTERWEIGHTS
42' (13 sections)	10
84' (25 sections)	18

Note: For dead loads (empty chute & hopper) over 1000# an additional support frame is needed. Contact factory.

595 E. Lugbill Road • Archbold, Ohio 43502  
Toll Free: 877-447-2648 • www.graniteind.com

**\*\*All Support Systems must be tied off to secure anchor point.**

**REQUIRED**

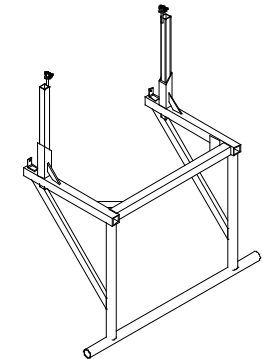

**A: Support Frame Package**

- TRS-HSL 1 Hopper Support Leg (Set)
- TRS-SF 1 Support Frame

**CHOOSE B1, B2 OR B3**

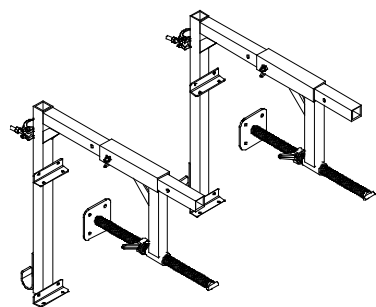

**B1: Window Outrigger Package**

- TRS-SJC 2 Screw jack Clamp
  - TRS-OR 2 Outrigger
- \*Sill plates lumber (not included)

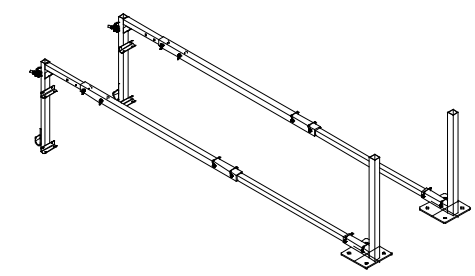

**B2: Roof Top Outrigger Package**

- TRS-RTCS6 2 Connecting Sleeve - 6'
  - TRS-OR 2 Outrigger
  - TRS-RTEA6 2 Extension Arm
  - TRS-RTWS 2 Weight Support
  - TRS-RTTB 2 Tie Back 50' Long
- \*Counter weights needed (based on chute length)

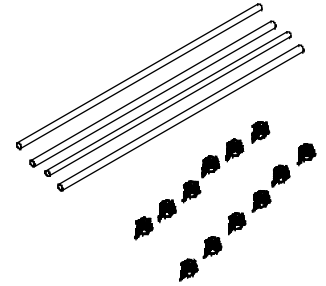

**B3: Scaffold Outrigger Package**

- TRS-8NE 4 8'L Support Tubes
- TRS-ES 12 Swivel Clamps

**OPTIONAL**

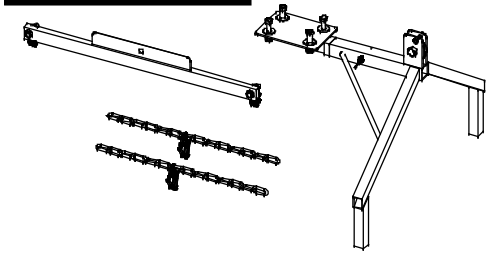

**C1: Winch Assembly Package**

- TRS-WPS 1 Winch/Pulley Stand
- TRS-WCA 1 Winch Cable Assembly
- TRS-LB 1 Lifting Bar
- TRS-LC 1 Lifting Chains (Set)
- TRS-WH 1 Winch

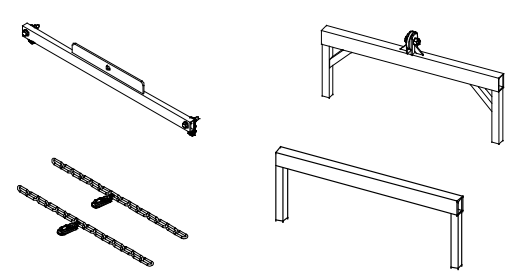

**C2: Griphoist Package**

- TRS-PS 1 Pulley Stand
- TRS-WCA 1 Winch Cable Assembly
- TRS-LB 1 Lifting Bar
- TRS-WB 1 Winch Bar
- TRS-LC 1 Lifting Chains (Set)
- TRS-GH 1 Griphoist



**Intermediate Hopper  
TRS-IH**  
Overall Ht. 48"  
Intake Throat 28" x 24"  
Bottom Diameter 28"



**Chute Section  
TRS-CH**  
Overall Ht. 48"  
Max. Usable Ht. 42"  
Top Diameter 32"  
Bottom Diameter 28"



**Intake Hopper  
TRS-HP**  
Overall Ht. 48"  
Intake Throat 28" x 24"  
Bottom Diameter 28"

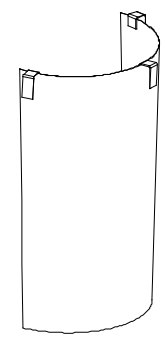

**Chute Liner  
TRS-CL**  
Overall Ht. 48"  
Liner Construction  
18 Ga. Steel



**Winch Hoist  
TRS-WH**



**Griphoist  
TRS-GH**

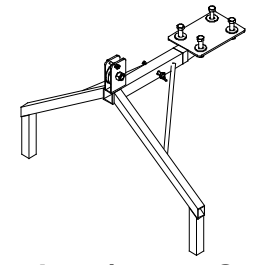

**Winch/Pulley Stand  
TRS-WPS**  
Overall Length 38"

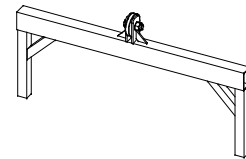

**Pulley Stand  
TRS-PS**

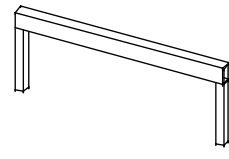

**Winch Bar  
TRS-WB**

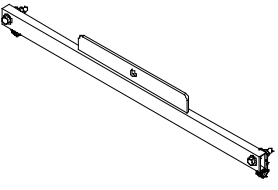

**Lifting Bar  
TRS-LB**  
Overall Length 38"



**Lifting Chains  
TRS-LC**  
Overall Length 28"

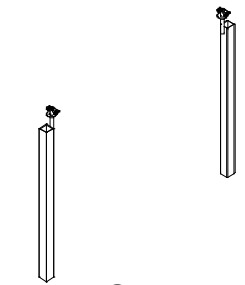

**Hopper Support Leg  
TRS-HSL**  
Overall Length 27-1/2"

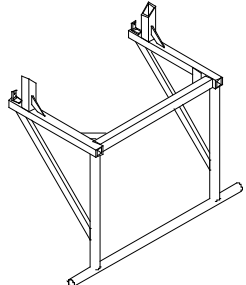

**Support Frame  
TRS-SF**

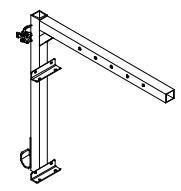

**Outrigger  
TRS-OR**

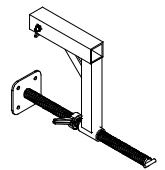

**Screw Jack  
Clamp  
TRS-SJC**

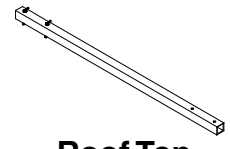

**Roof Top  
Connection  
Sleeve  
TRS-RTCS6**  
Overall Length 72"

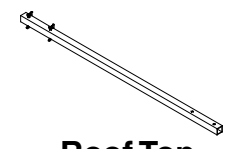

**Roof Top  
Extension  
Arm  
TRS-RTEA6**  
Overall Length 72"

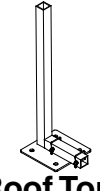

**Roof Top  
Weight  
Support  
TRS-RTWS**

*Picture  
N/A*

**Roof Top  
Tie Back  
TRS-RTTB**



**Slab Guard  
Rail Post  
SLBGPTT**

*Picture  
N/A*

**Concrete  
Roof Top  
Counter Wt.  
TRS-RTCW-C**

*Picture  
N/A*

**Steel  
Roof Top  
Counter Wt.  
TRS-RTCW-S**

*Picture  
N/A*

**8' Support  
Tube  
TC-8NE**

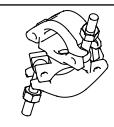

**Swivel  
Clamp  
TC-ES**

*Picture  
N/A*

**Winch Cable \  
Assembly w/Hook  
TRS-WCA**

*Picture  
N/A*

**Nylon Rope  
TRS-NYR**